

Article number: 03465045
 Description: Fluro Rod end EI 45D-2RS
 Note: 45

Measures

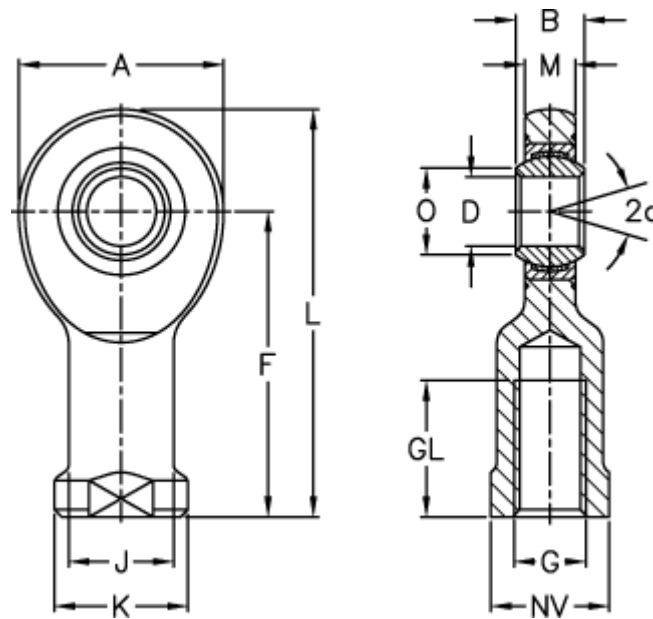

A	= 102	J	= 58
a (degrees)	= 7	K	= 70
B	= 32	L	= 196
D	= 45	M	= 27
Dynamic drive (kN)	= 240	NV	= 60
F	= 145	O	= 50.8
g	= M42x3	Static drive kN	= 263
GL	= 65	Weight	= 2500